

TRUE FLAME

OUTDOOR KITCHEN CATALOG



2026





Your
backyard
consciously
crafted.



Grills Griddles & Burners





40" TrueFlame Grill
TF40

TF Grill Series

The TrueFlame TF Grills redefine value with premium craftsmanship. Available in 40", 32", & 25" models, each is packed with all the features you could hope for in a grill. Interior and exterior lighting, square stainless steel cooking grates, heat zone separators for optimal control make gourmet grilling easy. With the Gold Standard Lifetime Warranty, this is a commercial-grade quality grill you can trust. Beauty & durability come together to create this truly high performance grill.

TF25

25" TrueFlame Grill
TF25 / TF25L



TF32

32" TrueFlame Grill
TF32 / TF32L



TF40

40" TrueFlame Grill
TF40 / TF40L





#304 Stainless Steel Construction

TrueFlame grills are constructed of the highest quality #304 stainless steel, adding a luxurious sheen and elegant touch to your backyard. This premium material is highly resistant to rust, discoloration, and wear, ensuring that your grill looks great and performs reliably for years to come.



14,000 BTU Cast Stainless Burners

A trusted Piezo Ignition mechanism ignites 14,000 BTU Cast Stainless Burners, supplying incredible heat for searing and grilling. These burners are cast from #304 stainless steel, ensuring longevity, durability, and performance.



Interior & Exterior Lighting

Two interior Halogen Lights help illuminate the expansive grilling surface, while a full-length LED strip gives maximum front panel visibility. The knobs feature a backlit ON/OFF indication light, so you can easily and safely see which burners are ignited.



IR Back Burner & Rotisserie Kit

The 32" and 40" models feature a 10,000 BTU Infrared Back Burner with an optional Rotisserie Kit, allowing you to enjoy perfectly cooked, juicy meats as they slowly turn on the spit, infusing them with delicious flavor and an irresistible aroma. Rotisserie Kit available for 25" Grill.



Square Cooking Grates

Heavy-duty Square Cooking Grates increase the contact surface with your food, offering beautiful grill lines and bolstering the flavor profile. These cooking grids are stainless steel, making them long-lasting and easy to clean.

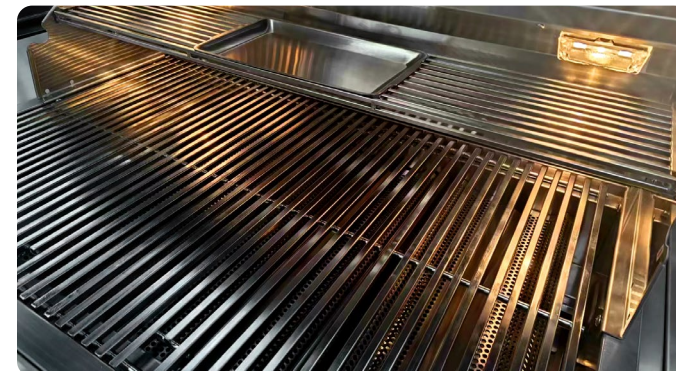

Warming Rack with Cooking Tray

A full-length, stainless steel warming rack not only adds to the useable cooking surface of your grill, but also features an inset, removable stainless steel tray for cooking vegetables, searing, roasting, and more.

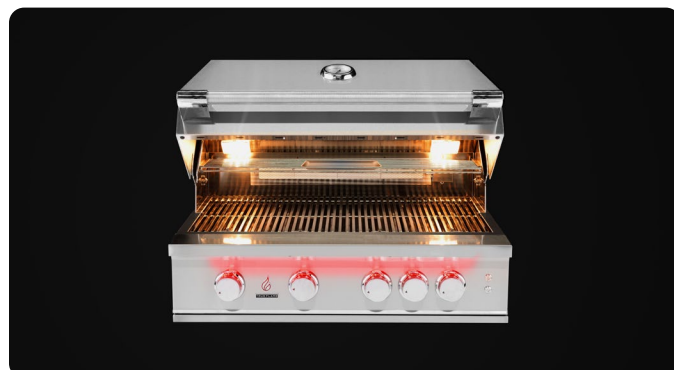

Multi-Position Hood Hinge

The balanced, Multi-Position Hood Hinge allows you to open your hood to any degree, gaining access to your food without losing too much heat—plus, the knurled finish of the stainless steel hood handle provides extra grip when lifting the hood.



#304 Stainless Steel Flame Tamers

The #304 Stainless Flame Tamers / Burner Covers are designed to provide superior protection and durability to your grill's burners, while also distributing heat and vaporizing drippings. They are easy to remove and install, making it effortless to maintain the quality and cleanliness of your grill.



Features

- Exterior Lighting Behind Each Knob Indicating On/Off Burner State
- Full Length Exterior LED Bar Above Knobs
- Halogen Interior Lighting
- Heat Zone Separators
- #304 Stainless Steel Flame Tamers / Burner Covers
- Square Stainless Steel Cooking Grates
- Constructed with #304 Stainless Steel
- 14,000 BTU #304 Cast Stainless Steel Burners
- Piezo & Manual Flash Tube Ignition
- 10,000 BTU Infrared Back Burner (32" & 40" Only)
- Balanced, Multi-Position Hood Hinge
- Knurled Heat-Resistant Handle
- Warming Rack with Inset, Removable Cooking Tray
- ETL Certified

Optional Accessories

- Griddle Plate
- Rotisserie Kit with 40 lb. Motor
- Deluxe Vinyl Grill Cover
- Drop-In Sear Burner (TF-IRB)



32" TFE Grill
TFE32

TFE Grill Series

The TrueFlame TFE Grills redefine value with premium craftsmanship. Available in a 32" & 25" models, each is packed with features and built-to-last. 14,000 BTU stainless steel tube burners, #304 stainless steel construction, & a meticulously designed profile ensure this grill not only stands the test of time but supports amazing culinary results. Elevate your outdoor environment with this commercial-grade, quality grill you can trust, all backed by the Gold Standard Lifetime Warranty.

TFE25

25" TFE Grill
TFE25 / TFE25L



TFE32

32" TFE Grill
TFE32 / TFE32L



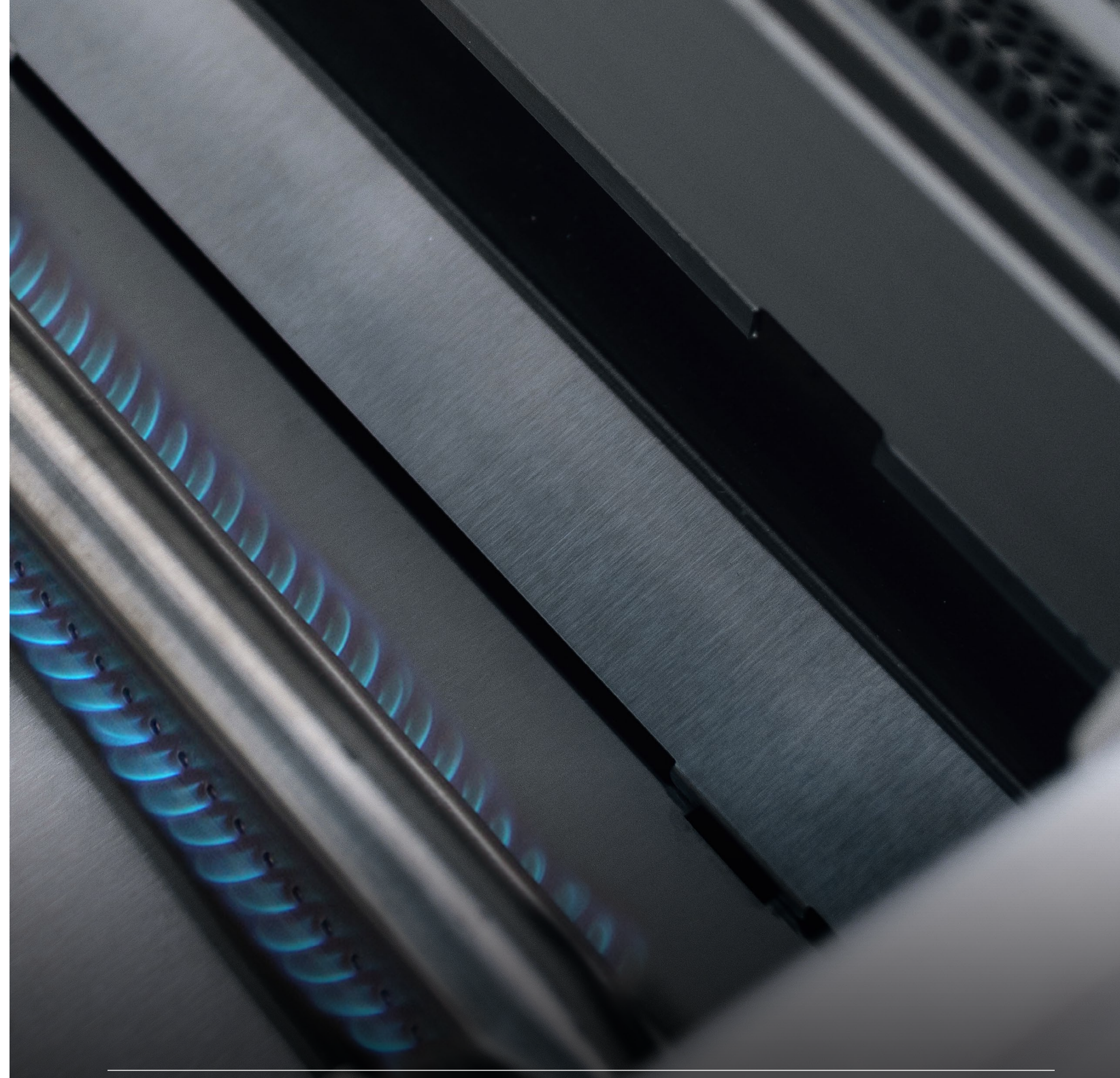

Features

- Heat Zone Separators
- #304 Stainless Steel Flame Tamers / Burner Covers
- 8mm Round Stainless Steel Cooking Grates
- Constructed with #304 Stainless Steel
- 14,000 BTU #304 Stainless Steel Tube Burners
- Knurled Heat-Resistant Handle
- Piezo & Manual Flash Tube Ignition
- ETL Certified

Optional Accessories

- Deluxe Vinyl Grill Cover
- Rotisserie Kit with 40 lb. Motor
- Griddle Plate



TrueFlame Deluxe Grill Cart
 CART-TF-40DC
 *Shown with 40" TF Grill, sold separately

Freestanding Carts

TrueFlame's premium grill carts offer an alternative solution to outdoor dining. Durable and sleek, these stainless steel carts feature propane tank storage, paper towel holder, and collapsible shelving. These cart models fit both the TF grills and TFE grills.



TrueFlame Deluxe Grill Cart
 CART-TF-25DC / CART-TF-32DC / CART-TF-40DC



*Shown with TF Grill, sold separately



*Shown with TFE Grill, sold separately

Features

- Commercial Grade Stainless Steel
- Magnetic Access Doors
- Front Locking Caster Wheels
- Interior Paper Towel Holder
- 2 Foldable Side Shelves
- Propane Tank Storage
- Side, Rear, and Bottom Ventilation

TrueFlame 30" Gas Griddle

TFG30

TF Griddle

Explore new flavors with the premium 30" Gas Griddle Grill. This #304 stainless steel, heavy-duty flat top grill is the perfect addition to your outdoor kitchen, diversifying your menu, and adding a host of new flavors. The expansive, 495-square-inch cooking surface is made of 8mm thick steel, powered by two 18,000 BTU U-Tube Burners below. The combined 36,000 BTUs of power guaranty searing heat, perfect for steaks, burgers, carne asada, eggs, pancakes, and more. The full-size, cover ensures your griddle plate is protected from the elements and always ready for the next meal. Fire up the Gas Griddle and take your culinary experiences to new heights.

TrueFlame 30" Gas Griddle

TFG30 / TFG30L



TrueFlame 30" Gas Griddle Cart

CART-TF-GRID30





Features

- Exterior Lighting Behind Each Knob Indicating On/Off Burner State
- Full Length Exterior LED Bar Above Knobs
- #304 Stainless Steel Construction
- 8mm Thick Stainless Steel Cooking Surface
- 495 Sq. Inches of Cooking Surface
- 18,000 BTU #304 Stainless Steel U-Tube Burners

- 36,000 Total BTU Output
- Heat Zone Separator, Allowing Dual-Temperature Cooking
- #304 Stainless Steel, Removable Lid
- High-Power, Reliable Flame-Thrower Ignition
- Large Capacity Drip Tray
- ETL Certified

Optional Accessories

- Deluxe Vinyl Grill & Cart Cover
- Grill Liner Available - GL-TFGRID30

TF Side & Power Burners

The TrueFlame Side & Power Burners combine the benefits of an indoor range with the joy of cooking outdoors. The perfect addition to your outdoor kitchen, these appliances offer convenience and performance to your outdoor oasis. With the matching design and exterior LED lights of the TrueFlame grill line, these burners bring high BTU output to boil, cook, or saute while you grill. Upgrade your outdoor kitchen today, so you're ready for the backyard gathering of a lifetime.

TrueFlame Double Side Burner

TFSB2 / TFSB2L

Features

- Exterior Lighting Behind Each Knob Indicating On/Off Burner State
- Full Length Exterior LED Bar Above Knobs
- Total BTU's 24,000
- Stainless Steel Construction
- Removable, Stainless Steel Lid
- Brass Plated Burners
- ETL Certified
- Deluxe Vinyl Cover Available

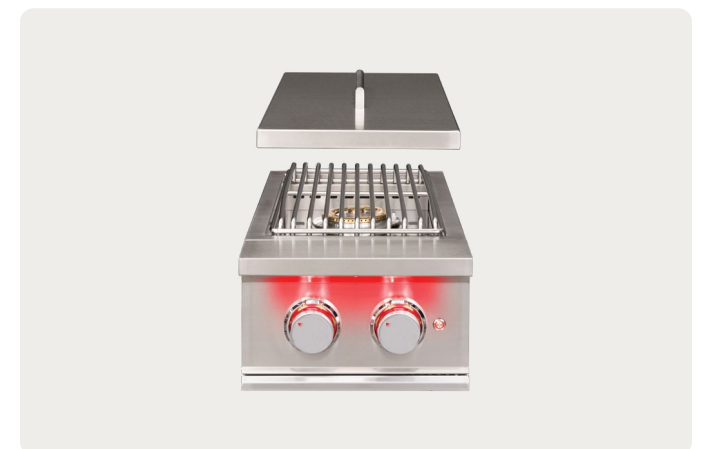

TrueFlame Power Burner

TFPB / TFPBL

Features

- Exterior Lighting Behind Each Knob Indicating On/Off Burner State
- Full Length Exterior LED Bar Above Knobs
- Total BTU's 60,000
- Stainless Steel Construction
- Removable, Stainless Steel Lid
- Dual, Cast Stainless Ring Burners
- Removable Wok Grate
- ETL Certified
- Deluxe Vinyl Cover Available



TrueFlame Double Side Burner

TFSB2

Enjoy fresh ingredients and chilled beverages with AMD Direct's extensive line of outdoor refrigeration. With up to 6.6 cubic feet of storage, these appliances will facilitate food preparation and storage needs for your outdoor kitchen. All AMD Direct refrigeration offers durable construction for the outdoors, temperature control, adjustable legs for leveling, and sleek design for function and beauty. Bring the function of your indoor refrigeration outside with matching performance and design.

AMD DIRECT

Outdoor Refrigeration



Outdoor Rated AMD Refrigeration

- #304 Stainless Steel Door & Handle
- UL Rated for Outdoor Use
- Interior LED Lighting
- Front Venting
- Auto-Defrost
- Electronic Temperature Controller w/ Digital Display
- Built-In Design
- Commercial & Residential Compliant
- Anti-Vibration System
- Trim Kits Available
- Certifications: ETL, DOE, CE

24" 5 Cu. Outdoor Rated Double Drawer Refrigerator

AMD-RFR-24DR2-A



- 114 Can Capacity
- 32°F - 72°F Temperature Range
- Black Interior Cabinet w/ Stainless Steel Drawers

15" 3.2 Cu. Outdoor Rated Refrigerator

AMD-RFR-15S



- 32°F - 50°F Temperature Range
- Black Interior
- 89 Can Capacity

15" 3.2 Cu. Outdoor Rated Refrigerator with Glass Door

AMD-RFR-15G



- 32°F - 50°F Temperature Range
- Black Interior
- Triple-Glazed, Tinted Glass Door
- 89 Can Capacity



24" 5 Cu. Outdoor Rated Double Drawer Refrigerator

AMD-RFR-24DR2-A

24" 5 Cu. Deluxe Outdoor Rated Single Zone Wine Cooler

AMD-RFR-24W

24" 5 Cu. Outdoor Rated Refrigerator

AMD-RFR-24S-B



- Reversible Door
- 161 Can Capacity
- Glass Shelves (x3)
- 32°F - 72°F Temperature Range
- Black Exterior & Interior Cabinet

24" 5 Cu. Outdoor Rated Refrigerator with Glass Door

AMD-RFR-24G



- Reversible Door
- 161 Can Capacity
- 32°F - 72°F Temperature Range
- Glass Shelves (x3)
- Black Exterior & Interior Cabinet
- Triple-Glazed, Tinted Glass Door

22" Refrigeration Series

The 22" Compact Refrigerator Series offers 4.3 cubic feet of storage, #304 stainless steel doors, and automatic interior lighting. Build them into an island or use them inside—these refrigerators will add a whole new level of convenience to your setup.

- Storage Capacity: 4.3 ft³
- Black Exterior & Interior Cabinet
- Black Wire Shelves (x4)
- Interior LED Light
- Full Range Mechanical Temperature Controls with 7 Settings
- Temperature Range: 0°C - 10°C / 32°F - 50°F
- 156 Can Capacity
- Energy Efficient Rating: DOE Household
- Certifications: ETL, DOE, CE
- Trim Kit Available: AMD-RTK-22

22" 4.3 Cu. Compact Refrigerator

AMD-RFR-22S



- #304 Stainless Steel Reversible Door

22" 4.3 Cu. Deluxe Compact Refrigerator

AMD-RFR-22D



- #304 Stainless Steel Reversible Door & Handle



24" 4.5 Cu Deluxe Outdoor Rated Dual Zone Wine Cooler

AMD-RFR-24WD

Wine Coolers

- Double-Glazed, Tinted Glass Door w/ #304 Stainless Steel Frame & Handle
- UL Rated for Outdoor Use
- Adjustable, Removable Wine Racks
- Interior LED Lighting
- Front Venting
- Auto-Defrost
- Electronic Temperature Controller w/ Digital Display
- Built-In Design
- Commercial & Residential Compliant
- Anti-Vibration System
- Trim Kits Available
- Certifications: ETL, DOE, CE



24" 4.5 Cu Deluxe Outdoor Rated Dual Zone Wine Cooler
AMD-RFR-24WD

24" 4.5 Cu Deluxe Outdoor Rated Dual Zone Wine Cooler
AMD-RFR-24WD

- 46 Bottle Capacity
- Upper Temperature Range: 41°F-50°F
- Lower Temperature Range: 50°F-64°F



15" 2.9 Cu. Outdoor Rated Dual Zone Wine Cooler
AMD-RFR-15WD

- 29 Bottle Capacity
- Upper Temperature Range: 41°F-50°F
- Lower Temperature Range: 50°F-64°F



24" 5 Cu. Deluxe Outdoor Rated Single Zone Wine Cooler
AMD-RFR-24W

- 52 Bottle Capacity
- 41°F-64°F Temperature Range



15" 3.2 Cu. Outdoor Rated Single Zone Wine Cooler
AMD-RFR-15W

- 34 Bottle Capacity
- 41°F - 64°F Temperature Range



Outdoor Rated Kegerator

- #304 Stainless Steel Door, Body & Handle
- UL Rated for Outdoor Use
- Interior LED Lighting
- Front Venting
- Auto-Defrost
- Electronic Temperature Controller w/ Digital Display
- Built-In Design
- Reversible Door
- Commercial & Residential Compliant
- Anti-Vibration System
- Trim Kits Available
- Certifications: ETL, DOE, CE

24" 6.6 Cu. Deluxe Outdoor Rated Kegerator

AMD-RFR-24DK

*Shown with Double Keg Tap for Kegerator, sold separately

- Single & Double Tap Towers Available
- 32°F - 50°F Temperature Range



Single Keg Tap for Kegerator

AMD-RFR-TAP-1

- Fits TF-RFR-24DK
- Includes Tap Tray, Single Hose, CO2 Kit (Tank & Regulator)



Double Keg Tap for Kegerator

AMD-RFR-TAP-2

- Fits TF-RFR-24DK
- Includes Tap Tray, Two Hoses, CO2 Kit (Tank & Regulator)



Outdoor Rated Ice Maker

50 LB. 15" Deluxe Outdoor Rated Ice Maker w/ Gravity Drain

AMD-IM-15

- #304 Stainless Steel Door Construction
- UL Rated for Outdoor Use
- Front Venting
- Reversible Door
- Auto-Defrost
- Electronic Temperature Controller
- Digital Display
- Gold Standard Lifetime Warranty



50 LB. 15" Deluxe Outdoor Rated Ice Maker w/ Gravity Drain

AMD-IM-15



Transform your outdoor living space into a culinary haven with our premium selection of outdoor kitchen sinks and bar preparation stations. Our sinks are the perfect addition to any outdoor kitchen, featuring durable stainless steel construction with options for under-mount, top-mount, or built-in installation. The Stainless Steel Beverage & Prep Station also makes for an entertainer's dream, featuring covered ice storage, sink, bottle opener, condiment bins, and more!

AMD DIRECT

Sinks & Bar Prep



Sinks & Bar Prep

15" Drop-In Sink & Hot/Cold Faucet

TF-NK-15D



- Double Handle Valve
- Hot & Cold Faucets
- Stopper/Strainer

19" Undermount Sink & 360° Hot/Cold Faucet

TF-NK-19U



- 360° Hot & Cold Faucet
- Stopper/Strainer
- 18 Gauge Stainless Steel

32" Farmhouse Sink

TF-NK-32FH-P



- Hot & Cold Pull Down Faucet
- Strainer
- Sink Grate
- Noise Cancelling Padding
- Built-In Drain & Plug

30" Beverage & Prep Station

TF-BC-30L-W

- 40 lb. Ice Compartment
- White LED Front Panel Lighting
- Sink & Faucet Combo
- 3 Condiment Trays
- Built-In Bottle Opener & Towel Rack
- Built-In Drain & Plug



32" Farmhouse Sink

TF-NK-32FH-P

AMD Ice Chests

With our grills heating things up, we have just what you need to keep cool. Choose between two sizes to optimize your serving station. With up to 40 lbs. of ice capacity, load them up with your favorite refreshments, snacks, or ingredients to make for a good time.

17" x 24" 1.7 Cu. Drop-In Cooler
(20lb Ice Capacity)

AMD-IC-17-A



- Built-In Drain & Plug

28" x 21" 2.7 Cu. Drop-In Cooler
(40lb Ice Capacity)

AMD-IC-28-A



- 40 lb. Ice Chest
- 3 Condiment Trays
- Built-In Drain & Plug



28" x 21" 2.7 Cu. Drop-In Cooler
(40lb Ice Capacity)

AMD-IC-28-A

Storage Solutions



Access Doors

TrueFlame's access doors give you elegant and convenient access to your island, utilities, and grill. Made with commercial-grade stainless steel, hidden hinge design, #304 stainless steel handle, heavy-duty flanges, reversible door mounting (excludes vented models), and magnetic latches.



33" Vented Double Access Door
TF-DD-33V-A



Double Access Door (26" - 45")
TF-DD-26-A / TF-DD-30-A / TF-DD-32-A
TF-DD-33-A / TF-DD-36-A / TF-DD-39-A
TF-DD-40-A / TF-DD-42-A / TF-DD-45-A



Vertical Access Door (16", 18", 20")
TF-DV-16-A / TF-DV-18-A
TF-DV-20-A

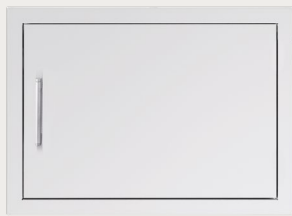

27" Horizontal Access Door
TF-DH-27-A



18" Vented Vertical Access Door (Left Handle)
TF-DV-18VL-A



18" Vented Vertical Access Door (Right Handle)
TF-DV-18VR-A

Door/Drawer Combos

These hingeless components with #304 stainless steel handles are specifically designed with versatility in mind. Whether you need a simple storage setup, LP tank drawer, paper towel holder, or weather-resistant dry storage shelving, these #304 stainless steel combos give you the options you need for a perfect outdoor setup.



2-Drawer & Access Door Combo (30", 32", 33", 36", 42")
TF-DC2-30-A / TF-DC2-32-A
TF-DC2-33-A / TF-DC2-36-A
TF-DC2-42-A



33" 3-Drawer & Access Door Combo
TF-DC3-33-A



33" 2-Drawer & Vented Trash or LP Tank Pullout Drawer Combo
TF-DC2-33LPV-A



33" 3-Drawer & Access Door Combo
TF-DC3-33-A

Storage Drawers

TrueFlame's line of drawers are feature-packed storage options that ensure you get exactly what you need in your backyard set up. Made with commercial-grade stainless steel, these drawers feature heavy-duty flanges, #304 stainless steel handle, and soft closing drawers.



17" Single Drawer

TF-DR1-17-A



17" Double Drawer

TF-DR2-17-A



17" Triple Drawer

TF-DR3-17-A



17" Vertical 2-Drawer & Paper Towel Holder Combo

TF-TDC-17-A



14" Narrow Trash Drawer

TF-TD1-14-A



20" Vented Liquid Propane Tank or Trash Drawer

TF-DR1-20LP-A



20" Trash & Recycling 2-Bin Pullout Drawer

TF-TD2-20-A



26" Utensil Drawer

TF-DR1-26U-A

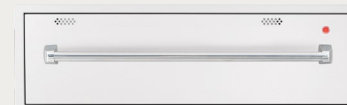

36" Warming Drawer

TF-WD-36



32" Double Horizontal Drawer

TF-DR2-32H-A



Masonry Storage

TrueFlame's line of Masonry Storage is perfect for islands with stone or brick finishes. The increased flange depth makes for a seamless fit and streamlined installation. These commercial-grade stainless steel components with hidden a hinge design and #304 stainless steel handle can also be used to add an attractive contrast to any island with stucco or Ameristone finishes.



20" Masonry Vertical Access Door
TF-DV-20M-A



27" Masonry Horizontal Access Door
TF-DH-27M-A



Masonry Double Access Door
(33", 45")
TF-DD-33M-A / TF-DD-45M-A



33" Masonry 2-Drawer
& Access Door Combo
TF-DC2-33M-A

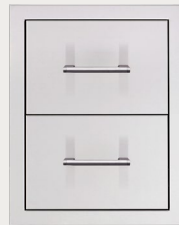

17" Masonry Double Drawer
TF-DR2-17M-A



14" Masonry Narrow Trash Drawer
TF-TD1-14M-A



17" Masonry Vertical 2-Drawer
& Paper Towel Holder Combo
TF-TDC-17M-A



12" Masonry Island Vent Panel
TF-IV-12M



33" Masonry
Double Access Door
TF-DD-33M-A

Dry Storage

This line of dry storage pantries is a solution that offers heavy-duty weather-resistant seals to give you peace of mind year-round—that means moisture and critters are locked out for good. Made with high quality #304 stainless steel, these pantries feature heavy-duty flanges, soft closing drawers, paper towel holder, #304 stainless steel handles, hidden hinge, and magnetic latches.

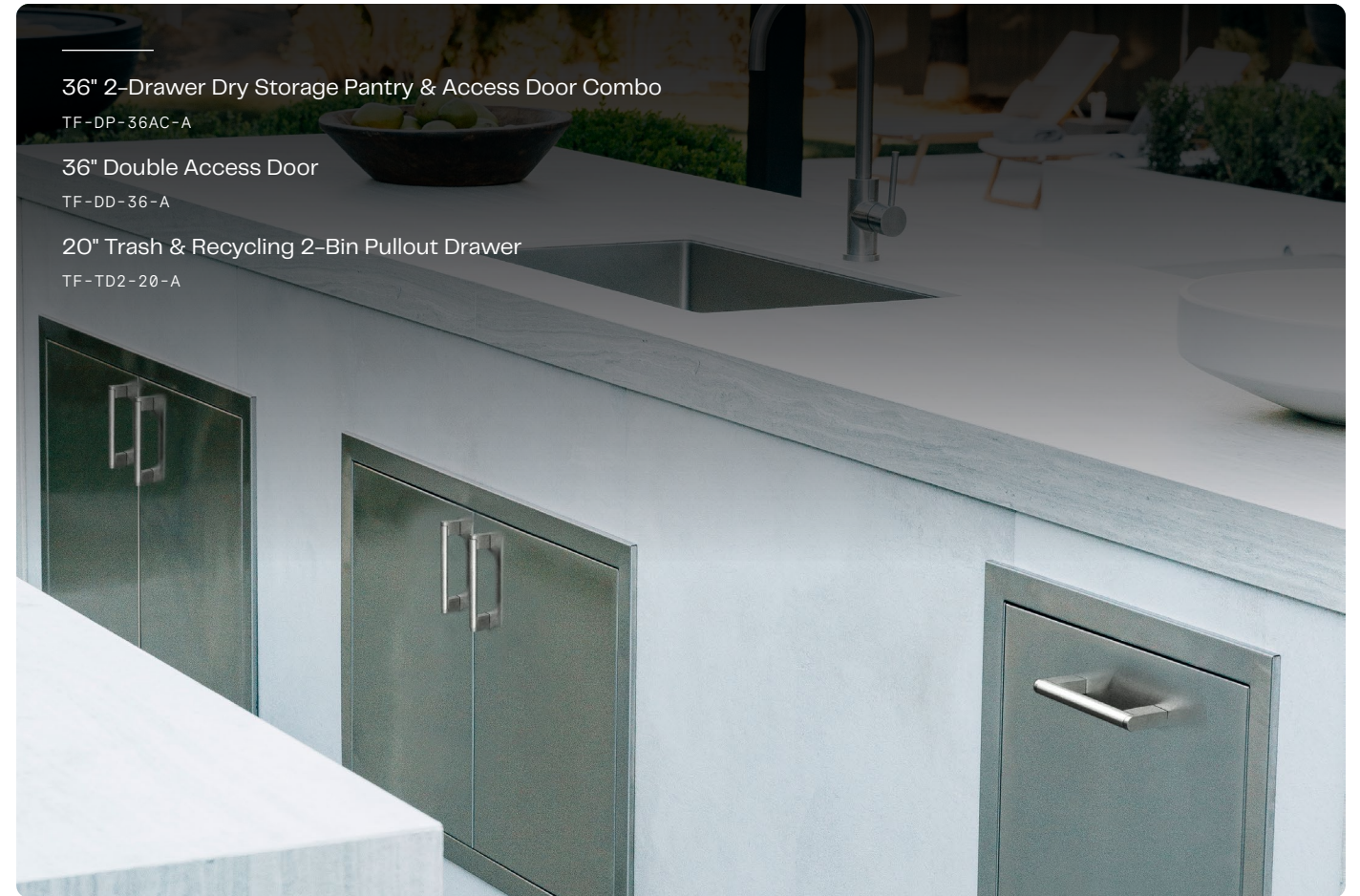

36" 2-Drawer Dry Storage Pantry & Access Door Combo

TF-DP-36AC-A

36" Double Access Door

TF-DD-36-A

20" Trash & Recycling 2-Bin Pullout Drawer

TF-TD2-20-A

36" 2-Drawer Dry Storage Pantry & Enclosed Cabinet Combo

TF-DP-36DC-A



36" 2-Drawer Dry Storage Pantry & Access Door Combo

TF-DP-36AC-A



Vent Hoods



Vent Hoods

Protect your outdoor kitchen with our commercial-grade Vent Hoods. Many BBQ Islands and outdoor kitchens are made under a pergola or porch. A vent hood provides the protection you need to ensure a safe and reliable entertaining space for years to come. Each Vent Hood features durable double-lined #304 stainless steel construction for maximum strength and protection, stainless steel top/side mounting ducting, and a matching sleek design. The Vent Hood not only protects your outdoor kitchen but also protects the chassis of your built-in grill from corrosion, adding to the longevity of your grill. Use TrueFlame Vent Hoods to make your outdoor kitchen a safe and entertaining space for your family and friends to enjoy.

- Sizes 36" / 42" / 48" / 60" / 72"
- 36" - 1000 CFM
- 42" / 48" / 60" / 72" - 2000 CFM
- Dual Venting / Top or Rear
- Duct Covers Available
- #304 Stainless Steel Construction
- 1/2" Mounting Bracket Included
- Spacer Kits Available

NEW PRODUCT

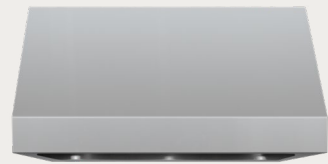

Vent Hoods (36", 42", 48", 60", 72")

TF-VH36-2 / TF-VH42-3 / TF-VH48-3
TF-VH60-3 / TF-VH72-3

*Includes 1/2" mounting bracket



12" Duct Cover (36", 42", 48", 60", 72")

TF-VH36-2-DC / TF-VH4272-DC (FITS 42" - 72")



Telescopic Duct Cover

TF-VH36-DCT / TF-VH4272-DCT



4" Spacer Brackets (36", 42", 48", 60")

TF-VH36-2-SP4 / TF-VH42-3-SP4
TF-VH48-3-SP4 / TF-VH60-3-SP4
TF-VH72-3-SP4



8" Spacer Brackets (36", 42", 48", 60")

TF-VH36-2-SP8 / TF-VH42-3-SP8
TF-VH48-3-SP8 / TF-VH60-3-SP8
TF-VH72-3-SP8



Wye Duct Fitting (Fits 42", 48", 60", 72")

TF-VH-3-WDF



Duct Cover Fillers (1/2", 4", 8")

TF-DCF-SPT / TF-DCF-SP4
TF-DCF-SP8

48" Vent Hood

TF-VH42-3

40" TrueFlame Grill

TF32



Make your kitchen the way you want it...TrueFlame offers a variety of miscellaneous conveniences, upgrades, and appliances to customize your outdoor space to your liking. All products feature high-grade stainless steel construction for durability and performance.

Grill & Island Accessories



Grill & Island Accessories

TrueFlame offers a variety of island accessories that help bring your outdoor kitchen to the next level. Deluxe covers, rotisserie kits, griddles, and more, our outdoor accessories complete your kitchen and ensure the highest quality culinary experience.



Grill Cover

TFGC-25 / TFGC-32 / TFGC-40



Cart Cover

CARTCOV-TF25 / CARTCOV-TF32
CARTCOV-TF40 / CARTCOV-TFGRID30

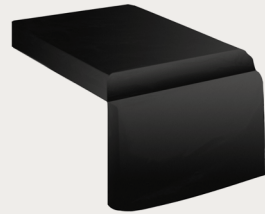

Side & Power Burner Cover

GRILLCOV-TFSB2 / GRILLCOV-TFPB

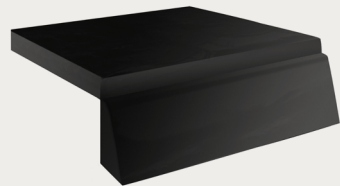

Gas Griddle Cover

TFGC-GRID30



Rotisserie Bag

TF-GRILLCOV-ROT32
TF-GRILLCOV-ROT44

*Rotisserie kit sold separately



Rotisserie Kit

TFRK-25 / TFRK-32 / TFRK-40



14" Island Vent Panel

TF-IV-14

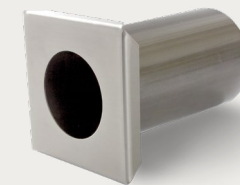

1.75" / 2" Umbrella Countertop Mounting Stanchion

TF-US-1 / TF-US-1L



Griddle Plate

TF-GP-14



Grill Liner

GL-TF25 / GL-TF32
GL-TF40 / GL-TFGRID30



Side & Power Burner Liner

GL-TFSB2 / GL-TFPB

*Access may differ based on model



Refrigerator Trim Kits

AMD-RTK-15-A / AMD-RTK-22
AMD-RTK-24SM-A / AMD-RTK-24LG-A

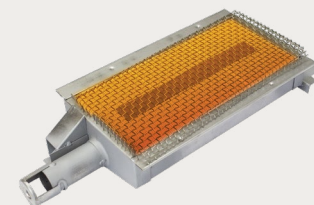

TrueFlame Drop-In Infrared Sear Burner

TF-IRB

*Not Compatible with TFE Series. TF Grills only.



TrueFlame Smoker Tray

TF-SMK



Rotisserie Kit

TFRK-40

Gas Timer & Mounting Plates



Gas Timer with Emergency Shutoff / Mounting Plate

TF-ESTOP1-0H

*Mounting plate sold separately



Expandable Masonry Gas Timer Kit

TF-ESTOP-CP-KIT



Gas Timer Locking Cabinet

TF-ESTOP-LC-KIT /
TF-ESTOP-RM-KIT

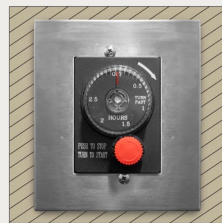

Gas Timer Recess Mount Kit

TF-ESTOP-RM-KIT

Wind Guards

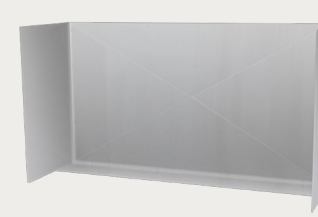

36" Stainless Steel Wind Guard
(Fits 25-32" Grills)

TFWG-36



48" Stainless Steel Wind Guard
(Fits 36-44" Grills)

TFWG-48

40" TrueFlame Grill
TF40



Product Dimensions



Product Dimensions



To view our recommended cutout dimensions, scan the QR Code or visit the link: www.trueflame.com/outdoor-kitchens/cutouts

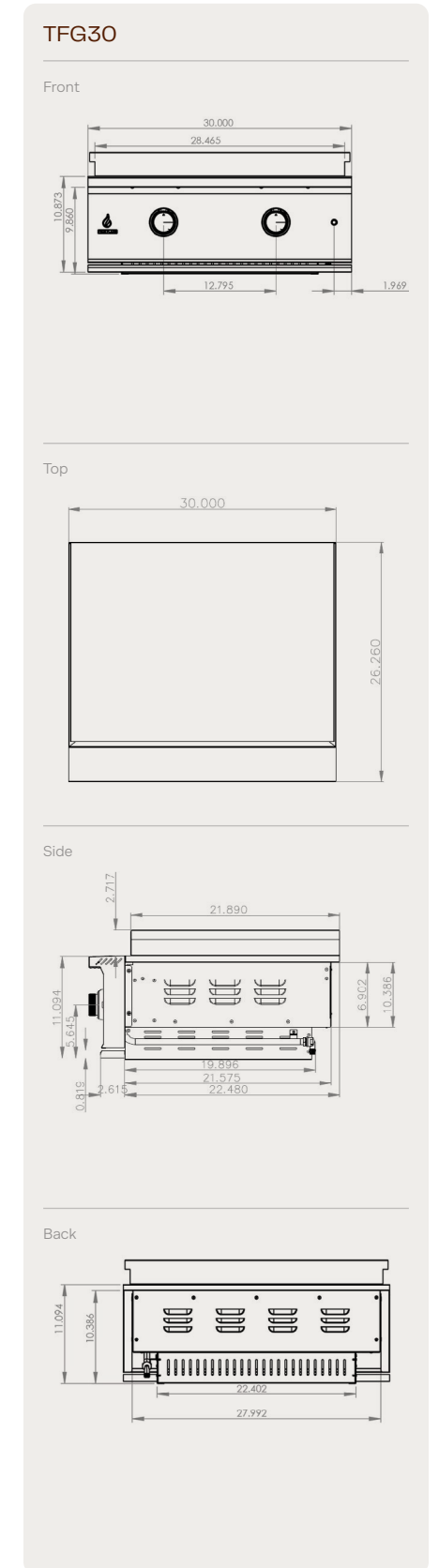
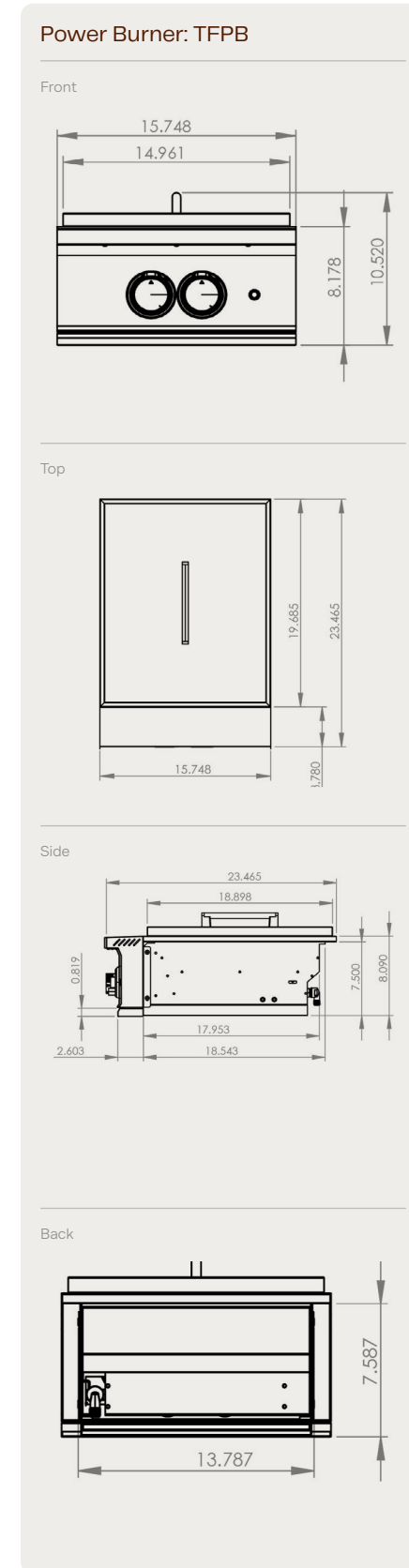
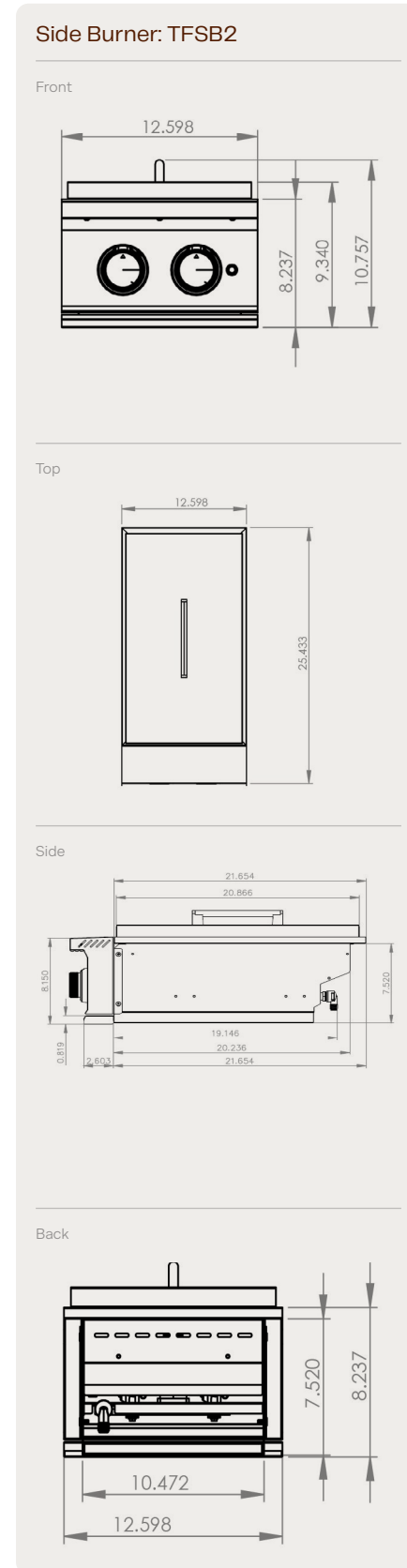
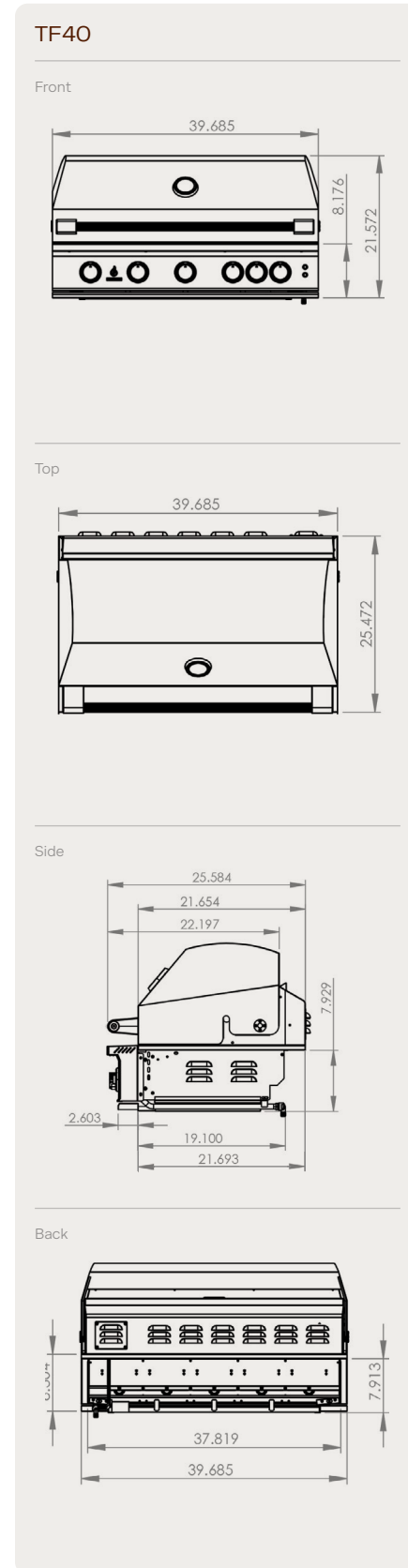
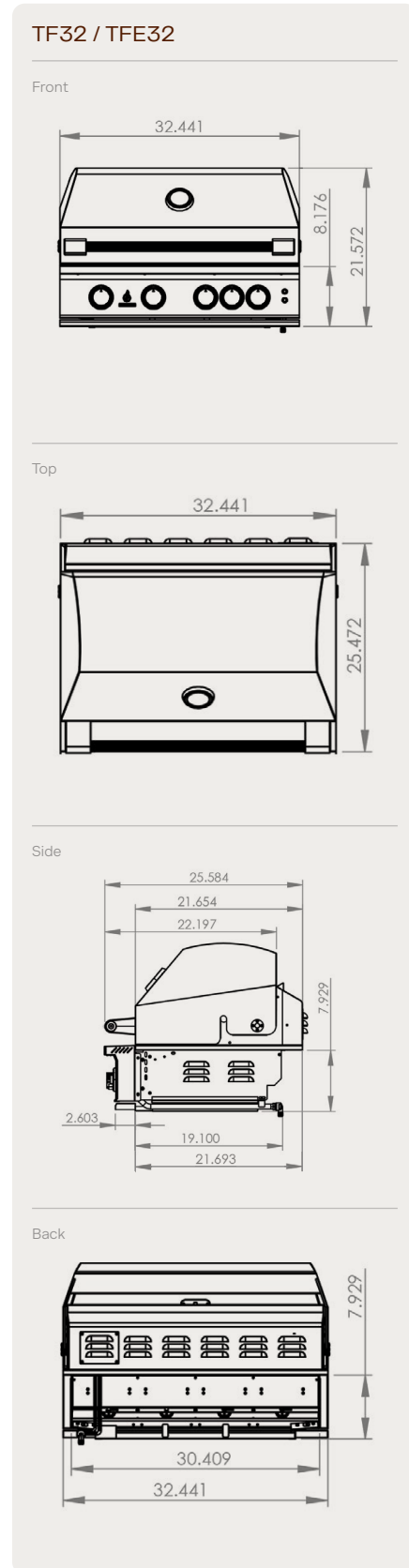
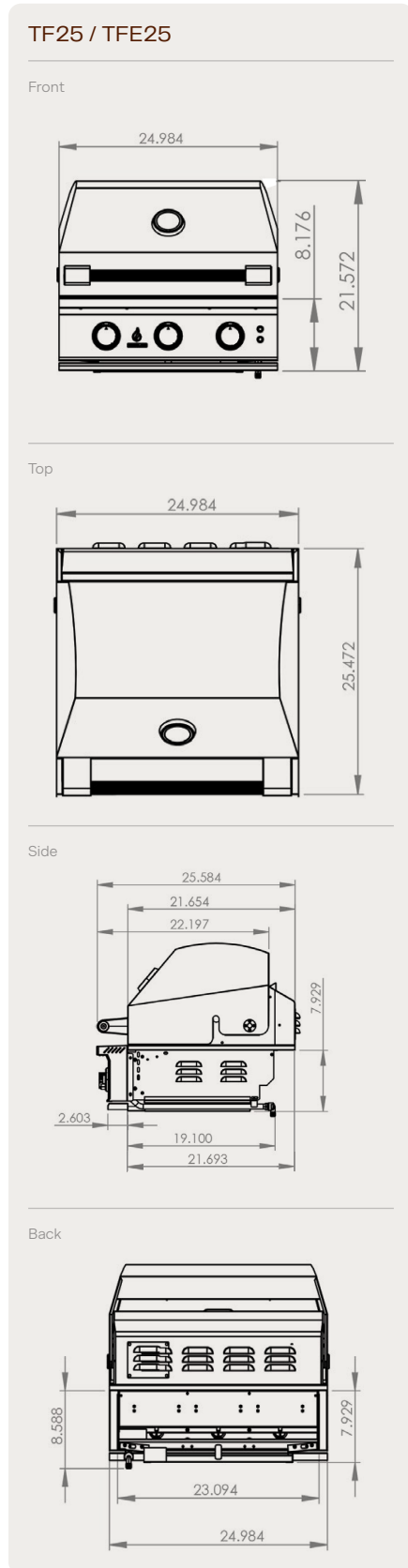

AMD Direct

Gold Standard Warranty

Your investment in AMD Direct products is backed by the strongest warranty in the industry. In addition to precision engineering and outstanding performance, AMD Direct products include our GOLD STANDARD LIFETIME WARRANTY with all replacement parts 100% non-prorated. Effective with purchases as of 3/1/23.

AMD Direct Warranty is valid for original purchaser at original site of delivery with proof of purchase and photo documentation only. Registration form must be submitted online within 30 days of the purchase date to validate the warranty. Warranty is void upon transfer of ownership. Warranty does not apply to products installed in any commercial, rental, or nonresidential application that have not maintained proper upkeep. Manufacturer is not responsible for labor or labor-related costs. Warranty does not cover discoloration, surface rust, corrosion, or oxidation, which may occur due to harsh environments, chemicals, or overheating. Warranty will not apply for damage resulting from improper installations, abuse, extreme environments, grease fires, or misuse. Proof of regular and proper maintenance is required. Coastal, humid, and/or salt environments are subject to manufacturer review. All out-of-box claims must be made within 30 days of purchase and must be made prior to installation. Any product installed damaged will be considered damaged during installation and not covered under warranty. Warranty and registration forms are available at www.amddirect.com/register. Please be advised – all display models are sold “as is” and the warranty covers the following items only: main burners (Gold Standard Lifetime Warranty), grates (Gold Standard Lifetime Warranty), burner covers (Gold Standard Lifetime Warranty). All warranties are subject to the review and approval of the manufacturer.

Gas Appliances (Grills, Side/Power Burners, Gas Griddle)

- Gold Standard Lifetime Warranty on Construction and Manufacturer Defects
- Gold Standard Lifetime Warranty on Stainless Steel Construction
- Gold Standard Lifetime Warranty on Cooking Grates, Rib Racks, Smoker Trays, Griddle Plates, Burners, Burner Covers, Valves, Flame Tamers, Infrared Drop-In Burners, Infrared Back Burners, Heatzone Separators, Warming Racks, Rotisserie Kits & Temperature Gauges
- 3 Year Warranty on all Other Parts, Components, & Electrical, Including: LED Bulbs, Wire Harness, Switches; Power Source Wire; Transformer; Interior Halogen Light Wire & Bulb

Vent Hoods, Refrigeration, Cold Storage & Sinks, Vent Hoods

Vent Hoods

- Gold Standard Lifetime Warranty on all Stainless Steel Construction
- 3 Year Warranty on Blowers, LED Lighting, Wiring Harness and Switches

Refrigeration Models 15", 22" & 24"

- 3 Year Warranty Replacement on the Sealed Refrigeration System
- 1 Year Warranty on Transformer, LED Bulbs, LED Harness, Power Source Wire, LED Switches, Interior Halogen Light Wire/Bulbs

Cold Storage & Sinks

- Gold Standard Lifetime Warranty on Ice Chest
- Gold Standard Lifetime Warranty on Drains & Faucets

Drawers, Doors, Grill Liners & Carts

- Gold Standard Lifetime Warranty on Construction, Workmanship and Materials for all Stainless Steel Parts, Including Doors, Drawers, Grill Liners, & Carts
- 3 Year Warranty on Electrical (Warming Drawers)

Covers

- Gold Standard Lifetime Warranty on Covers, Including Grills, Carts, Side/Power Burners, Gas Griddle

Commercial Applications

Covers

- Gold Standard Lifetime Warranty on Workmanship, Construction, & Manufacturer Defects for all Commercial and/or Hospitality Applications
- Warranty is Void Upon Misuse, Including Lack of Regular Cleaning, Vandalism, or Theft
- Warranty is Valid Only if Regular Maintenance is Exercised. Due to the Nature of Commercial Applications (Multiple Users, Lack of Control of Use, etc.) Regular Maintenance is Mandatory



Version 121025

17322 Gothard Street,
Huntington Beach, CA 92647

800.966.8126
AMDDirect.com



Outdoor Kitchens

By TrueFlame

17322 Gothard Street
Huntington Beach, CA 92647

Customer Care (800) 966-8126
6:00am-4:30pm PST

POP-TF-KIT-CATALOG-2026
Version 121025